



200MHz, CMOS OPERATIONAL AMPLIFIER

FEATURES

- UNITY-GAIN BANDWIDTH: 450MHz
- WIDE BANDWIDTH: 200MHz GBW
- HIGH SLEW RATE: 360V/ μ s
- LOW NOISE: 5.8nV/ $\sqrt{\text{Hz}}$
- EXCELLENT VIDEO PERFORMANCE:
DIFF GAIN: 0.02%, DIFF PHASE: 0.05°
0.1dB GAIN FLATNESS: 75MHz
- INPUT RANGE INCLUDES GROUND
- RAIL-TO-RAIL OUTPUT (within 100mV)
- LOW INPUT BIAS CURRENT: 3pA
- THERMAL SHUTDOWN
- SINGLE-SUPPLY OPERATING RANGE: 2.5V to 5.5V
- *Micro*SIZE PACKAGES

APPLICATIONS

- VIDEO PROCESSING
- ULTRASOUND
- OPTICAL NETWORKING, TUNABLE LASERS
- PHOTODIODE TRANSIMPEDANCE AMPS
- ACTIVE FILTERS
- HIGH-SPEED INTEGRATORS
- ANALOG-TO-DIGITAL (A/D) CONVERTER
INPUT BUFFERS
- DIGITAL-TO-ANALOG (D/A) CONVERTER
OUTPUT AMPLIFIERS
- BARCODE SCANNERS
- COMMUNICATIONS

DESCRIPTION

The OPAx356 series high-speed, voltage-feedback CMOS operational amplifiers are designed for video and other applications requiring wide bandwidth. The OPAx356 is unity gain stable and can drive large output currents. Differential gain is 0.02% and differential phase is 0.05°. Quiescent current is only 8.3mA per channel.

OPAx356 is optimized for operation on single or dual supplies as low as 2.5V ($\pm 1.25\text{V}$) and up to 5.5V ($\pm 2.75\text{V}$). Common-mode input range for the OPAx356 extends 100mV below ground and up to 1.5V from V+. The output swing is within 100mV of the rails, supporting wide dynamic range.

The OPAx356 series is available in single (SOT23-5 and SO-8), and dual (MSOP-8 and SO-8) versions. Multichannel versions feature completely independent circuitry for lowest crosstalk and freedom from interaction. All are specified over the extended -40°C to $+125^{\circ}\text{C}$ range.

OPAx356 RELATED PRODUCTS

FEATURES	PRODUCT
200MHz, Rail-to-Rail Output, CMOS, Shutdown	OPAx355
38MHz, Rail-to-Rail Input/Output, CMOS	OPAx350
75MHz, Rail-to-Rail Output	OPAx631
150MHz, Rail-to-Rail Output	OPAx634
Differential Input/Output, 3.3V Supply	THS412x

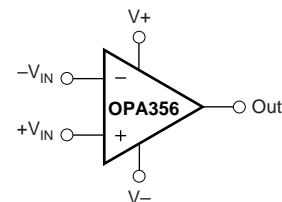

Please be aware that an important notice concerning availability, standard warranty, and use in critical applications of Texas Instruments semiconductor products and disclaimers thereto appears at the end of this data sheet.

ABSOLUTE MAXIMUM RATINGS⁽¹⁾

Supply Voltage, V+ to V-	7.5V
Signal Input Terminals, Voltage ⁽²⁾	(V-) - 0.5V to (V+) + 0.5V
Current ⁽²⁾	10mA
Output Short-Circuit ⁽³⁾	Continuous
Operating Temperature	-55°C to +150°C
Storage Temperature	-65°C to +150°C
Junction Temperature	+160°C
Lead Temperature (soldering, 10s)	+300°C

NOTE: (1) Stresses above these ratings may cause permanent damage. Exposure to absolute maximum conditions for extended periods may degrade device reliability. These are stress ratings only, and functional operation of the device at these or any other conditions beyond those specified is not implied. (2) Input terminals are diode-clamped to the power-supply rails. Input signals that can swing more than 0.5V beyond the supply rails should be current limited to 10mA or less. (3) Short-circuit to ground one amplifier per package.



ELECTROSTATIC DISCHARGE SENSITIVITY

This integrated circuit can be damaged by ESD. Texas Instruments recommends that all integrated circuits be handled with appropriate precautions. Failure to observe proper handling and installation procedures can cause damage.

ESD damage can range from subtle performance degradation to complete device failure. Precision integrated circuits may be more susceptible to damage because very small parametric changes could cause the device not to meet its published specifications.

PACKAGE/ORDERING INFORMATION

PRODUCT	PACKAGE-LEAD	PACKAGE DESIGNATOR ⁽¹⁾	SPECIFIED TEMPERATURE RANGE	PACKAGE MARKING	ORDERING NUMBER ⁽²⁾	TRANSPORT MEDIA, QUANTITY
OPA356AIDBV	SOT23-5	DBV	-40°C to +125°C	OAAI	OPA356AIDBVT	Tape and Reel, 250
"	"	"	"	"	OPA356AIDBVR	Tape and Reel, 3000
OPA356AID	SO-8	D	-40°C to +125°C	OPA356A	OPA356AID	Rails, 100
"	"	"	"	"	OPA356AIDR	Tape and Reel, 2500
OPA2356AIDGK	MSOP-8	DGK	-40°C to +125°C	AYI	OPA2356AIDGKT	Tape and Reel, 250
"	"	"	"	"	OPA2356AIDGKR	Tape and Reel, 2500
OPA2356AID	SO-8	D	-40°C to +125°C	OPA2356A	OPA2356AID	Rails, 100
"	"	"	"	"	OPA2356AIDR	Tape and Reel, 2500

NOTES: (1) For the most current specifications and package information, refer to our web site at www.ti.com. (2) Models labeled with "T" indicate smaller quantity tape and reel, "R" indicates large quantity tape and reel and "D" indicates rails of specified quantity.

PIN CONFIGURATIONS

Top View

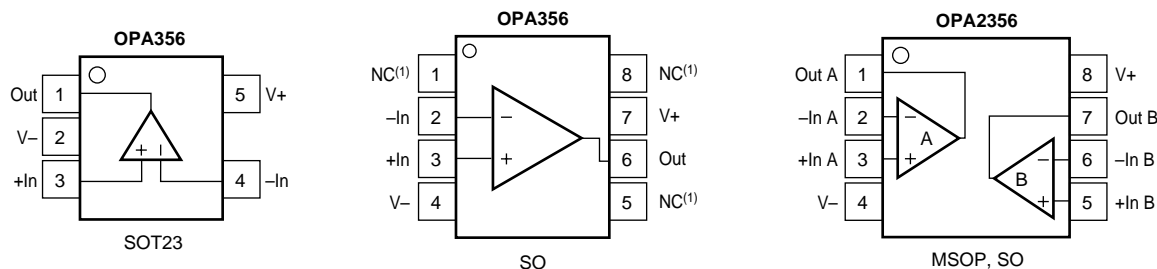

NOTE: (1) NC means no internal connection.

ELECTRICAL CHARACTERISTICS: $V_S = +2.7V$ to $+5.5V$ Single Supply

Boldface limits apply over the specified temperature range, $T_A = -40^\circ C$ to $+125^\circ C$.

At $T_A = +25^\circ C$, $R_F = 604\Omega$, $R_L = 150\Omega$, Connected to $V_S/2$, unless otherwise noted.

PARAMETER	CONDITION	OPA356AIDBV, AID, OPA2356AIDGK, AID			UNITS
		MIN	TYP	MAX	
OFFSET VOLTAGE					
Input Offset Voltage	V_{OS}		± 2	± 9	mV
vs Temperature	dV_{OS}/dT		± 7	± 15	mV/ $^\circ C$
vs Power Supply	PSRR	$V_S = +2.7V$ to $+5.5V$, $V_{CM} = V_S/2 - 0.15V$	± 80	± 350	$\mu V/V$
INPUT BIAS CURRENT					
Input Bias Current	I_B		3	± 50	pA
Input Offset Current	I_{OS}		± 1	± 50	pA
NOISE					
Input Noise Voltage Density	e_n	$f = 1MHz$	5.8		nV/\sqrt{Hz}
Current Noise Density	i_n	$f = 1MHz$	50		fA/\sqrt{Hz}
INPUT VOLTAGE RANGE					
Common-Mode Voltage Range	V_{CM}		$(V-) - 0.1$	$(V+) - 1.5$	V
Common-Mode Rejection Ratio	CMRR	$V_S = +5.5V$, $-0.1V < V_{CM} < +4.0V$	66	80	dB
		Specified Temperature Range	66		dB
INPUT IMPEDANCE					
Differential			$10^{13} \parallel 1.5$		$\Omega \parallel pF$
Common-Mode			$10^{13} \parallel 1.5$		$\Omega \parallel pF$
OPEN-LOOP GAIN					
	OPA356	$V_S = +5V$, $0.3V < V_O < 4.7V$	84	92	dB
	OPA2356	$V_S = +5V$, $0.3V < V_O < 4.7V$	80		dB
		$V_S = +5V$, $0.4V < V_O < 4.6V$	80		dB
FREQUENCY RESPONSE					
Small-Signal Bandwidth	f_{-3dB}	$G = +1$, $V_O = 100mVp-p$, $R_F = 0\Omega$	450		MHz
	f_{-3dB}	$G = +2$, $V_O = 100mVp-p$, $R_L = 50\Omega$	100		MHz
	f_{-3dB}	$G = +2$, $V_O = 100mVp-p$, $R_L = 150\Omega$	170		MHz
	f_{-3dB}	$G = +2$, $V_O = 100mVp-p$, $R_L = 1k\Omega$	200		MHz
Gain-Bandwidth Product	GBW	$G = +10$, $R_L = 1k\Omega$	200		MHz
Bandwidth for 0.1dB Gain Flatness	$f_{0.1dB}$	$G = +2$, $V_O = 100mVp-p$, $R_F = 560\Omega$	75		MHz
Slew Rate	SR	$V_S = +5V$, $G = +2$, 4V Output Step	300/-360		V/ μs
Rise-and-Fall Time		$G = +2$, $V_O = 200mVp-p$, 10% to 90%	2.4		ns
		$G = +2$, $V_O = 2Vp-p$, 10% to 90%	8		ns
Settling Time, 0.1%		$V_S = +5V$, $G = +2$, 2V Output Step	30		ns
0.01%		$V_S = +5V$, $G = +2$, 2V Output Step	120		ns
Overload Recovery Time		$V_{IN} \cdot Gain = V_S$	8		ns
Harmonic Distortion					
2 nd Harmonic		$G = +2$, $f = 1MHz$, $V_O = 2Vp-p$, $R_L = 200\Omega$	-81		dBc
3 rd Harmonic		$G = +2$, $f = 1MHz$, $V_O = 2Vp-p$, $R_L = 200\Omega$	-93		dBc
Differential Gain Error		NTSC, $R_L = 150\Omega$	0.02		%
Differential Phase Error		NTSC, $R_L = 150\Omega$	0.05		degrees
Channel-to-Channel Crosstalk	OPA2356	$f = 5MHz$	-90		dB
OUTPUT					
Voltage Output Swing from Rail		$V_S = +5V$, $R_L = 150\Omega$, $A_{OL} > 84dB$	0.2	0.3	V
Voltage Output Swing from Rail		$V_S = +5V$, $R_L = 1k\Omega$	0.1		V
Voltage Output Swing from Rail		$I_O = \pm 100mA$	0.8	1	V
Output Current, Continuous ⁽¹⁾	I_O		± 60		mA
Maximum Output Current, Peak ⁽¹⁾	I_O	$V_S = +5V$	± 100		mA
Maximum Output Current, Peak ⁽¹⁾	I_O	$V_S = +3V$		± 80	mA
Short Circuit Current				+250/-200	mA
Closed-Loop Output Impedance		$f < 100kHz$		0.02	Ω
POWER SUPPLY					
Specified Voltage Range	V_S		2.7	5.5	V
Operating Voltage Range				2.5 to 5.5	V
Quiescent Current (per amplifier)	I_Q	$V_S = +5V$, $I_O = 0$		8.3	mA
		Specified Temperature Range		14	mA

ELECTRICAL CHARACTERISTICS: $V_S = +2.7V$ to $+5.5V$ Single Supply (Cont.)

Boldface limits apply over the specified temperature range, $T_A = -40^{\circ}C$ to $+125^{\circ}C$.

At $T_A = +25^{\circ}C$, $R_F = 604\Omega$, $R_L = 150\Omega$, Connected to $V_S/2$, unless otherwise noted.

PARAMETER	CONDITION	OPA356AIDBV, AID, OPA2356AIDGK, AID			UNITS
		MIN	TYP	MAX	
THERMAL SHUTDOWN					
Junction Temperature					
Shutdown			160		$^{\circ}C$
Reset from Shutdown			140		$^{\circ}C$
TEMPERATURE RANGE					
Specified Range		-40		125	$^{\circ}C$
Operating Range		-55		150	$^{\circ}C$
Storage Range		-65		150	$^{\circ}C$
Thermal Resistance	θ_{JA}				$^{\circ}C/W$
SOT23-5, MSOP-8			150		$^{\circ}C/W$
SO-8			125		$^{\circ}C/W$

NOTES: (1) See typical characteristic "Output Voltage Swing vs Output Current".

TYPICAL CHARACTERISTICS

At $T_A = +25^\circ\text{C}$ and $V_S = 5\text{V}$, $G = +2$, $R_F = 604\Omega$, $R_L = 150\Omega$ connected to $V_S/2$, unless otherwise noted.

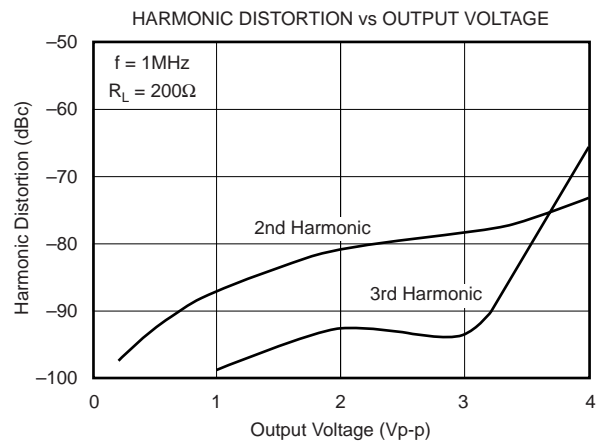
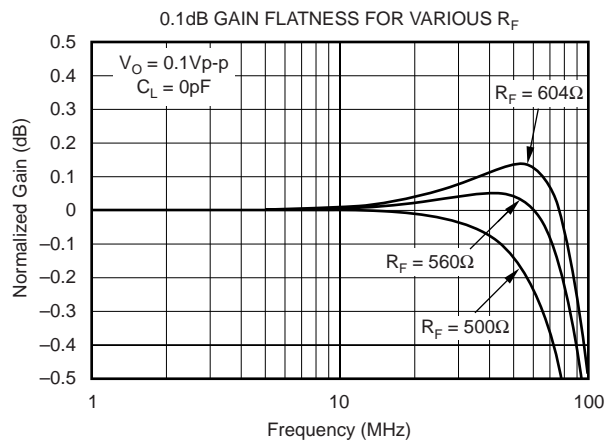
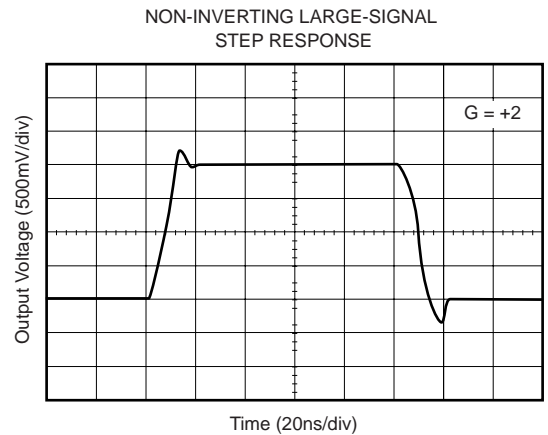
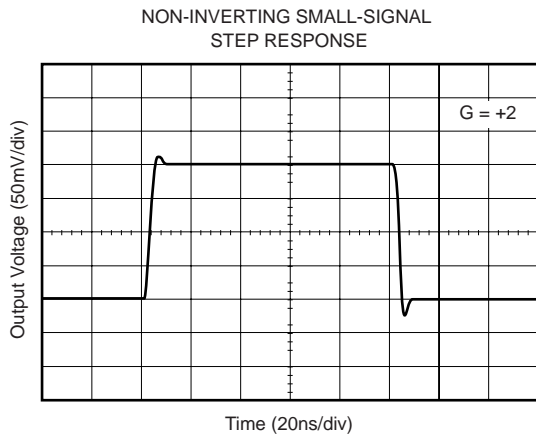
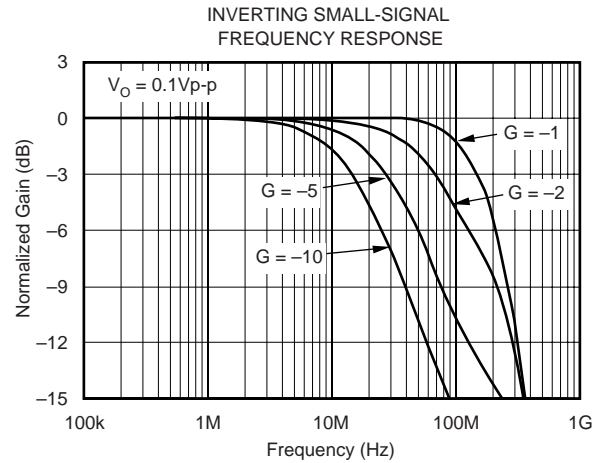
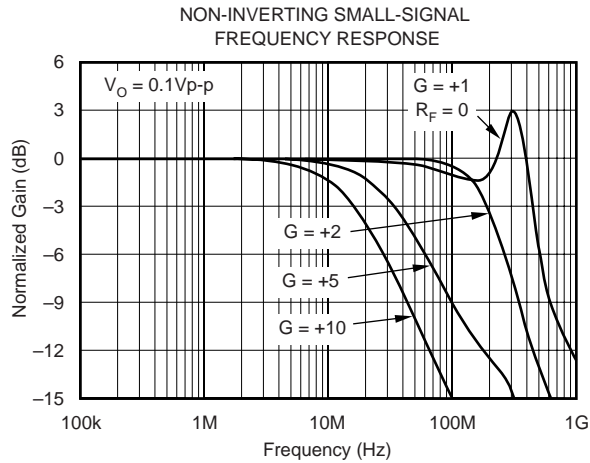

TYPICAL CHARACTERISTICS (Cont.)

At $T_A = +25^\circ\text{C}$ and $V_S = 5\text{V}$, $G = +2$, $R_F = 604\Omega$, $R_L = 150\Omega$ connected to $V_S/2$, unless otherwise noted.

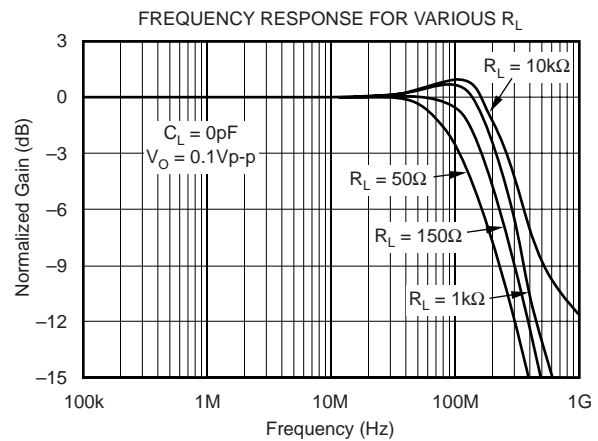
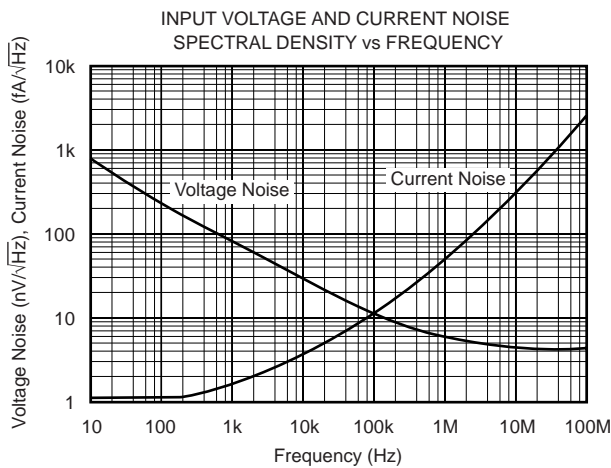
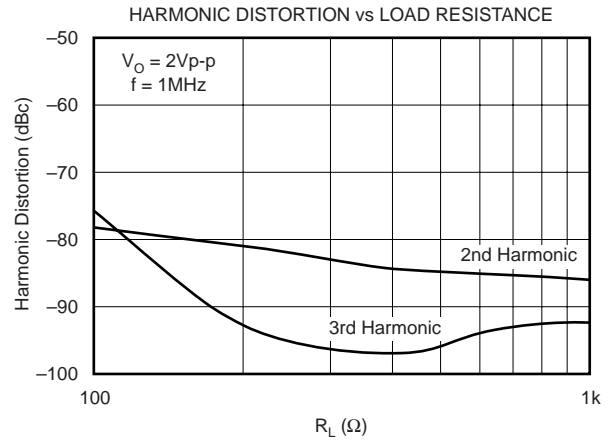
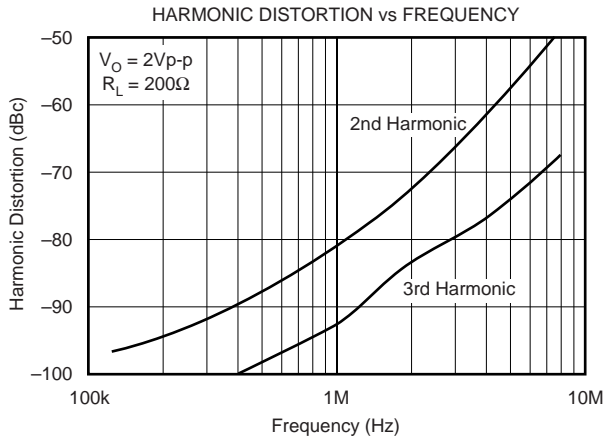
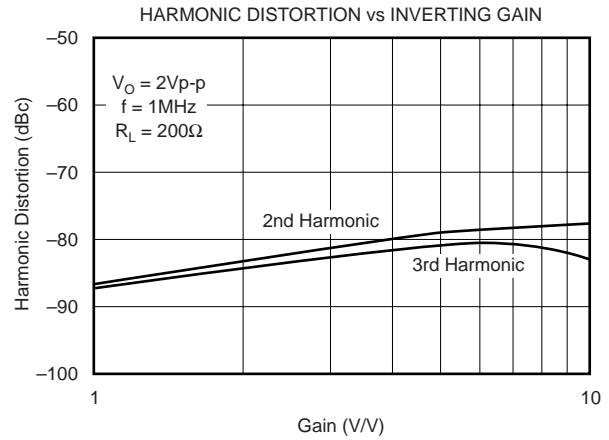
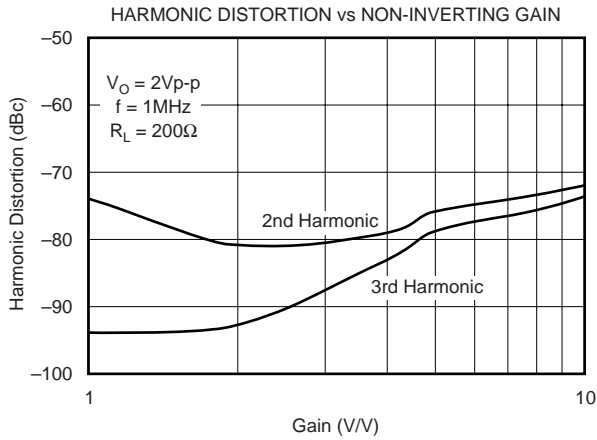

TYPICAL CHARACTERISTICS (Cont.)

At $T_A = +25^\circ\text{C}$ and $V_S = 5\text{V}$, $G = +2$, $R_F = 604\Omega$, $R_L = 150\Omega$ connected to $V_S/2$, unless otherwise noted.

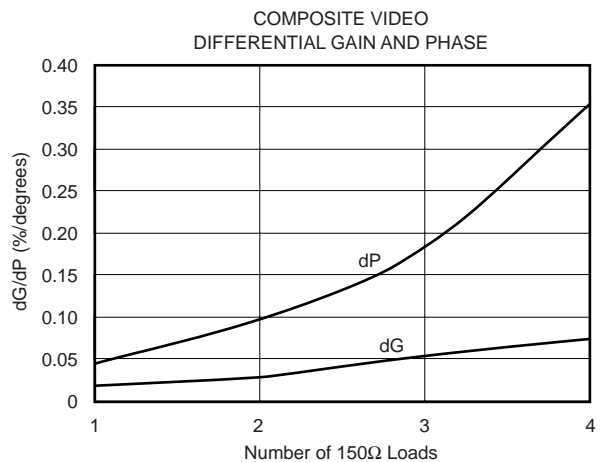
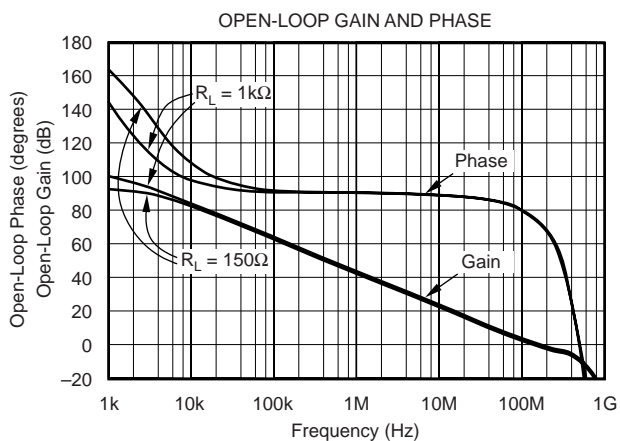
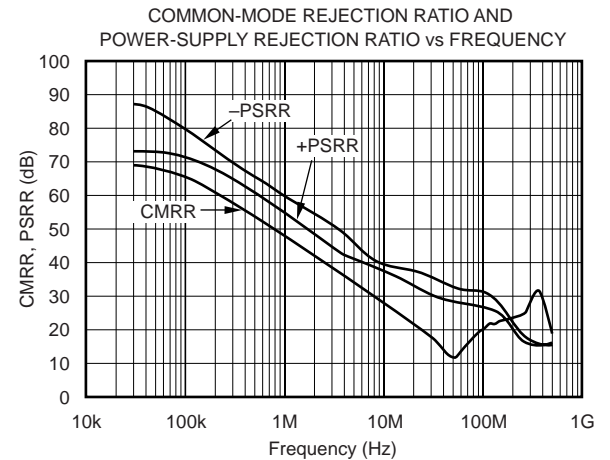
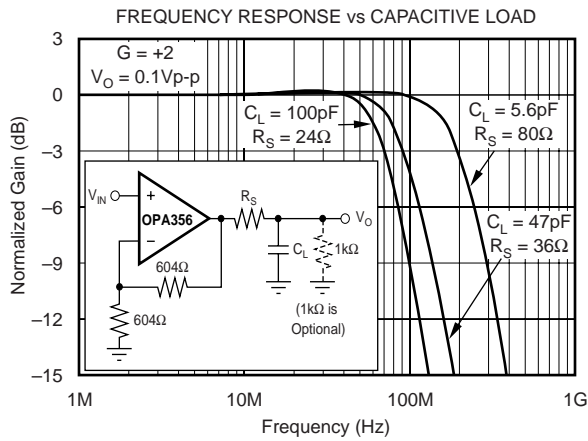
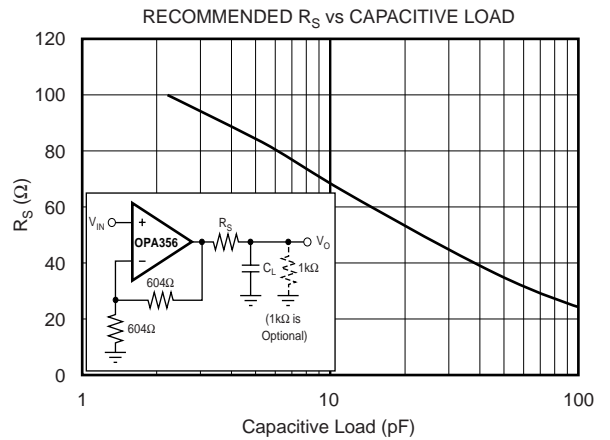
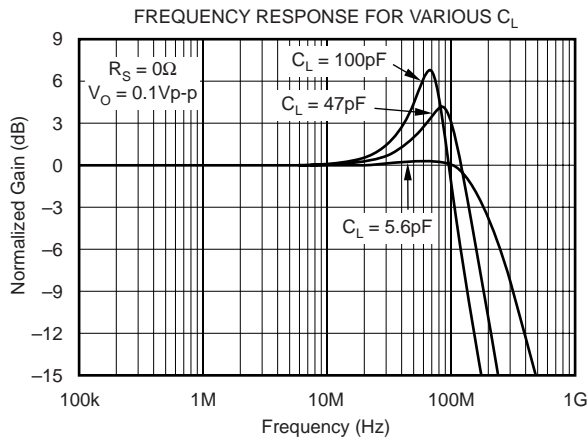

TYPICAL CHARACTERISTICS (Cont.)

At $T_A = +25^\circ\text{C}$ and $V_S = 5\text{V}$, $G = +2$, $R_F = 604\Omega$, $R_L = 150\Omega$ connected to $V_S/2$, unless otherwise noted.

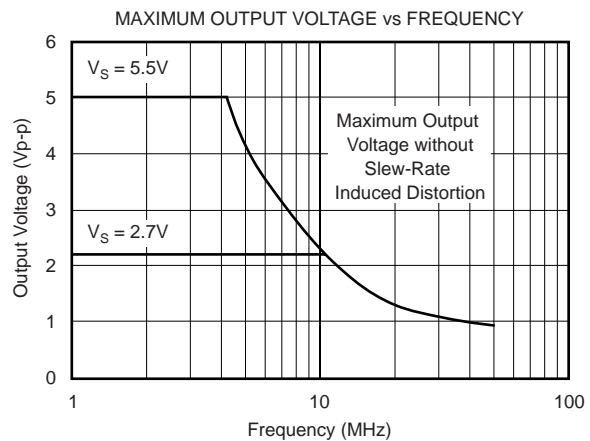
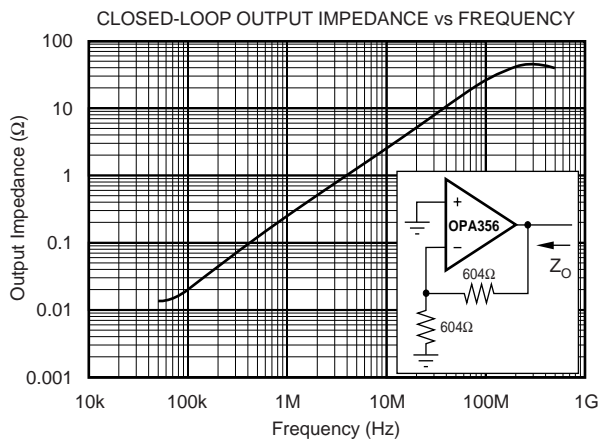
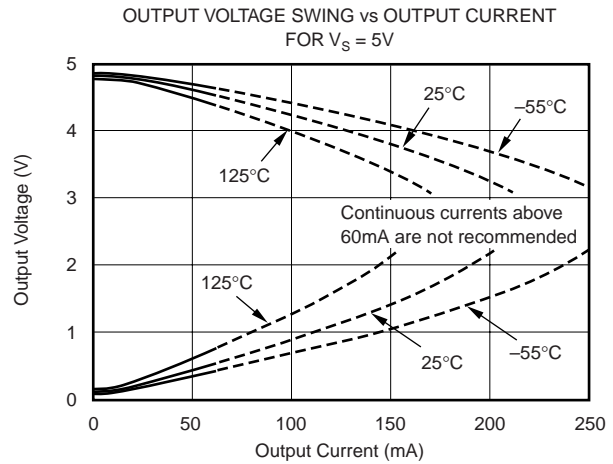
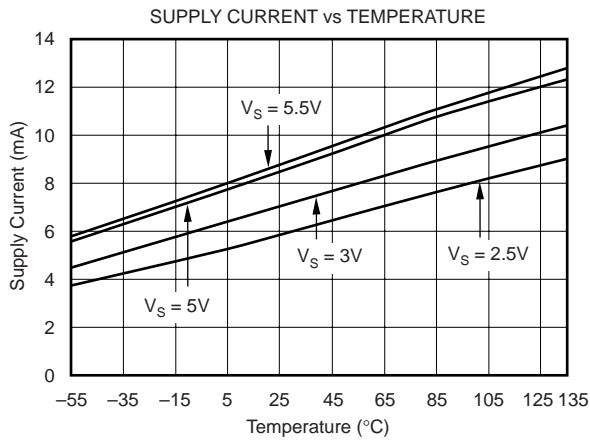
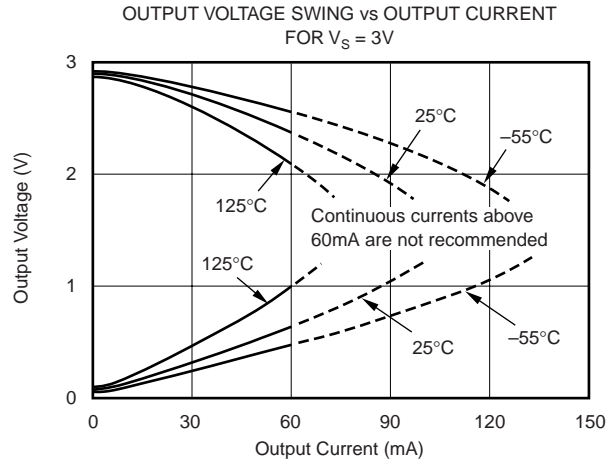
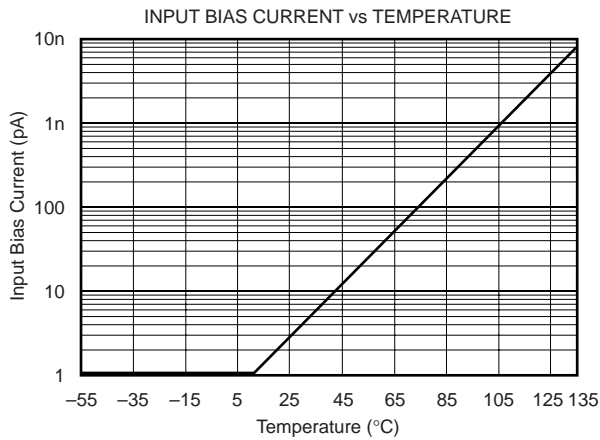

TYPICAL CHARACTERISTICS (Cont.)

At $T_A = +25^\circ\text{C}$ and $V_S = 5\text{V}$, $G = +2$, $R_F = 604\Omega$, $R_L = 150\Omega$ connected to $V_S/2$, unless otherwise noted.

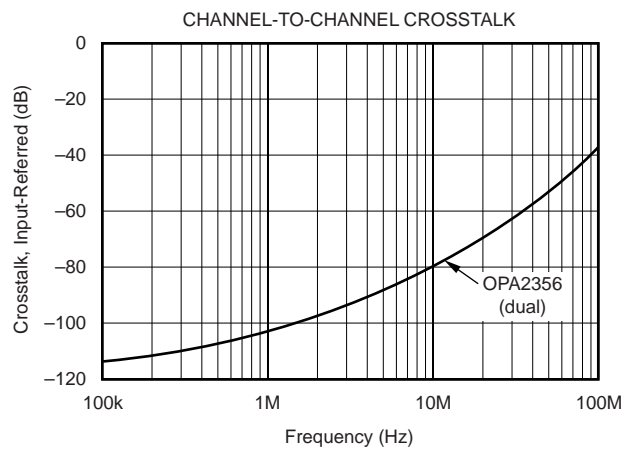
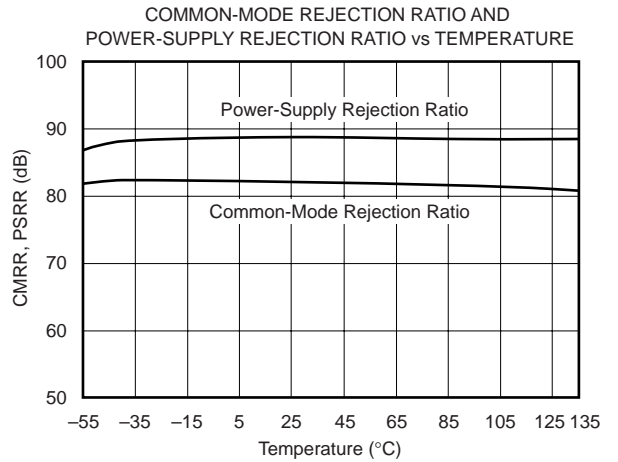
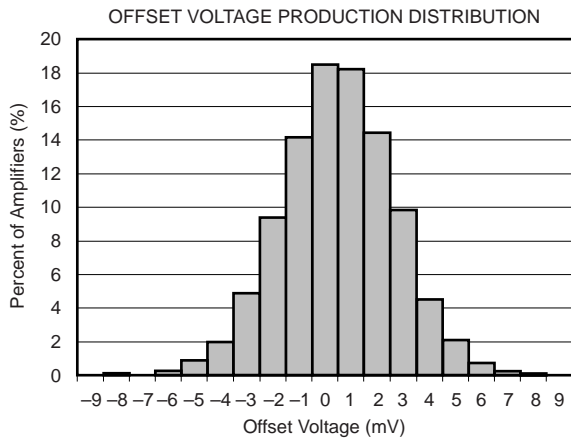
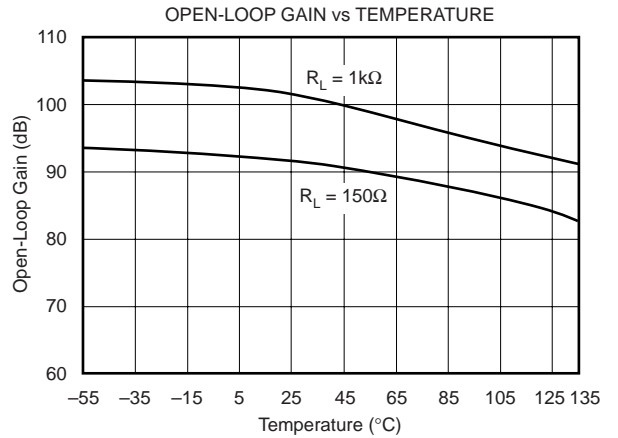
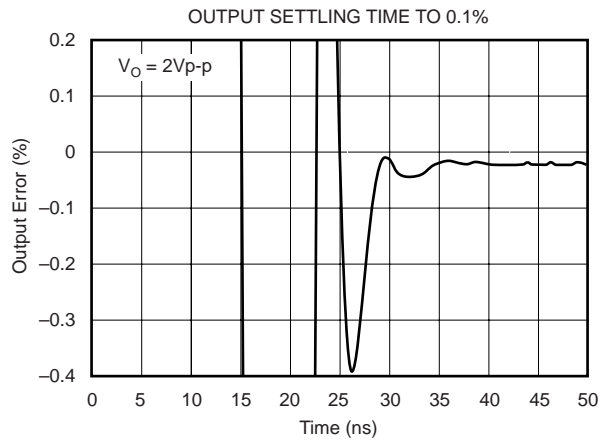

APPLICATIONS INFORMATION

The OPAx356 series is a CMOS, high-speed, voltage feed-back, operational amplifier designed for video and other general-purpose applications. It is available as a single or dual op amp.

The amplifier features a 200MHz gain bandwidth and 360V/ μ s slew rate, but it is unity-gain stable and can be operated as a +1V/V voltage follower.

Its input common-mode voltage range includes ground, allowing the OPAx356 to be used in virtually any single-supply application up to a supply voltage of +5.5V.

PCB LAYOUT

Good high-frequency PC board layout techniques should be employed for the OPAx356. Generous use of ground planes, short direct signal traces, and a suitable bypass capacitor located at the V+ pin will assure clean, stable operation. Large areas of copper also provide a means of dissipating heat that is generated within the amplifier in normal operation.

Sockets are definitely not recommended for use with any high-speed amplifier.

A 10 μ F ceramic bypass capacitor is the minimum recommended value; adding a 1 μ F or larger tantalum capacitor in parallel can be beneficial when driving a low-resistance load. Providing adequate bypass capacitance is essential to achieving very low harmonic and intermodulation distortion.

OPERATING VOLTAGE

The OPAx356 is specified over a power-supply range of +2.7V to +5.5V (± 1.35 to ± 2.75 V). However, the supply voltage may range from +2.5V to +5.5V (± 1.25 V to ± 2.75 V). Supply voltages higher than 7.5V (absolute maximum) can permanently damage the amplifier.

Parameters that vary significantly over supply voltage or temperature are shown in the "Typical Characteristics" section of this data sheet.

OUTPUT DRIVE

The OPAx356 output stage is capable of driving a standard back-terminated 75 Ω video cable. By back-terminating a transmission line, it does not exhibit a capacitive load to its driver. A properly back-terminated 75 Ω cable does not appear as capacitance; it presents only a 150 Ω resistive load to the OPAx356 output.

The output stage can supply high short-circuit current (typically over 200mA). Therefore, an on-chip thermal shutdown circuit is provided to protect the OPAx356 from dangerously high junction temperatures. At 160°C, the protection circuit will shut down the amplifier. Normal operation will resume when the junction temperature cools to below 140°C.

NOTE: It is not recommended to run a continuous DC current in excess of ± 60 mA. Refer to the graph of "Output Voltage Swing vs Output Current", shown in the "Typical Characteristics" section of this data sheet.

INPUT AND ESD PROTECTION

All OPAx356 pins are static protected with internal ESD protection diodes tied to the supplies, as shown in Figure 1.

These diodes will provide overdrive protection if the current is externally limited to 10mA by the source or by a resistor.

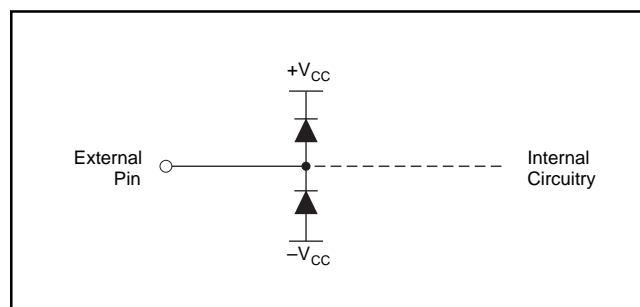
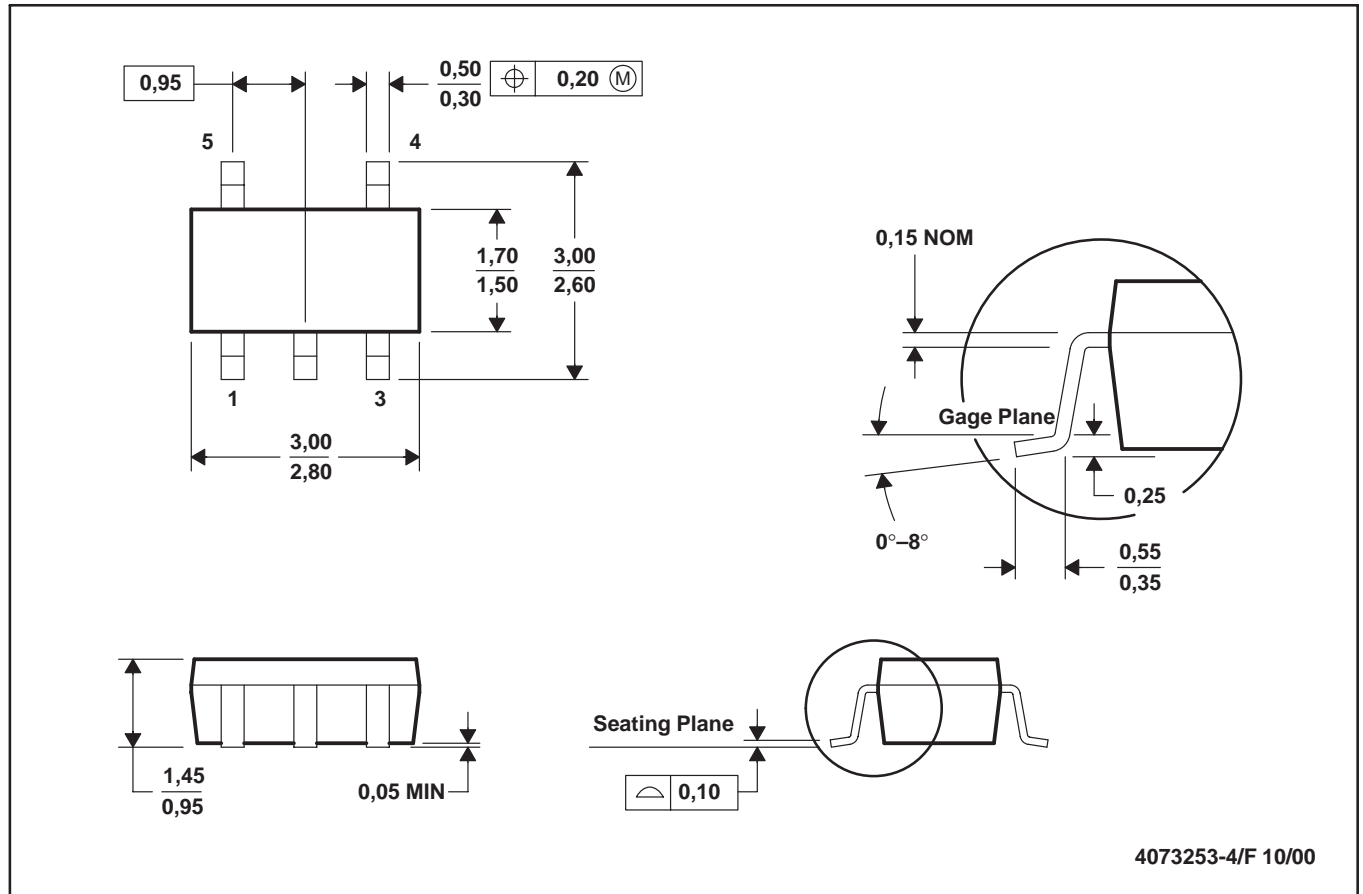

FIGURE 1. Internal ESD Protection.

DBV (R-PDSO-G5)

PLASTIC SMALL-OUTLINE



- NOTES: A. All linear dimensions are in millimeters.
 B. This drawing is subject to change without notice.
 C. Body dimensions do not include mold flash or protrusion.
 D. Falls within JEDEC MO-178

DGK (R-PDSO-G8)

PLASTIC SMALL-OUTLINE PACKAGE

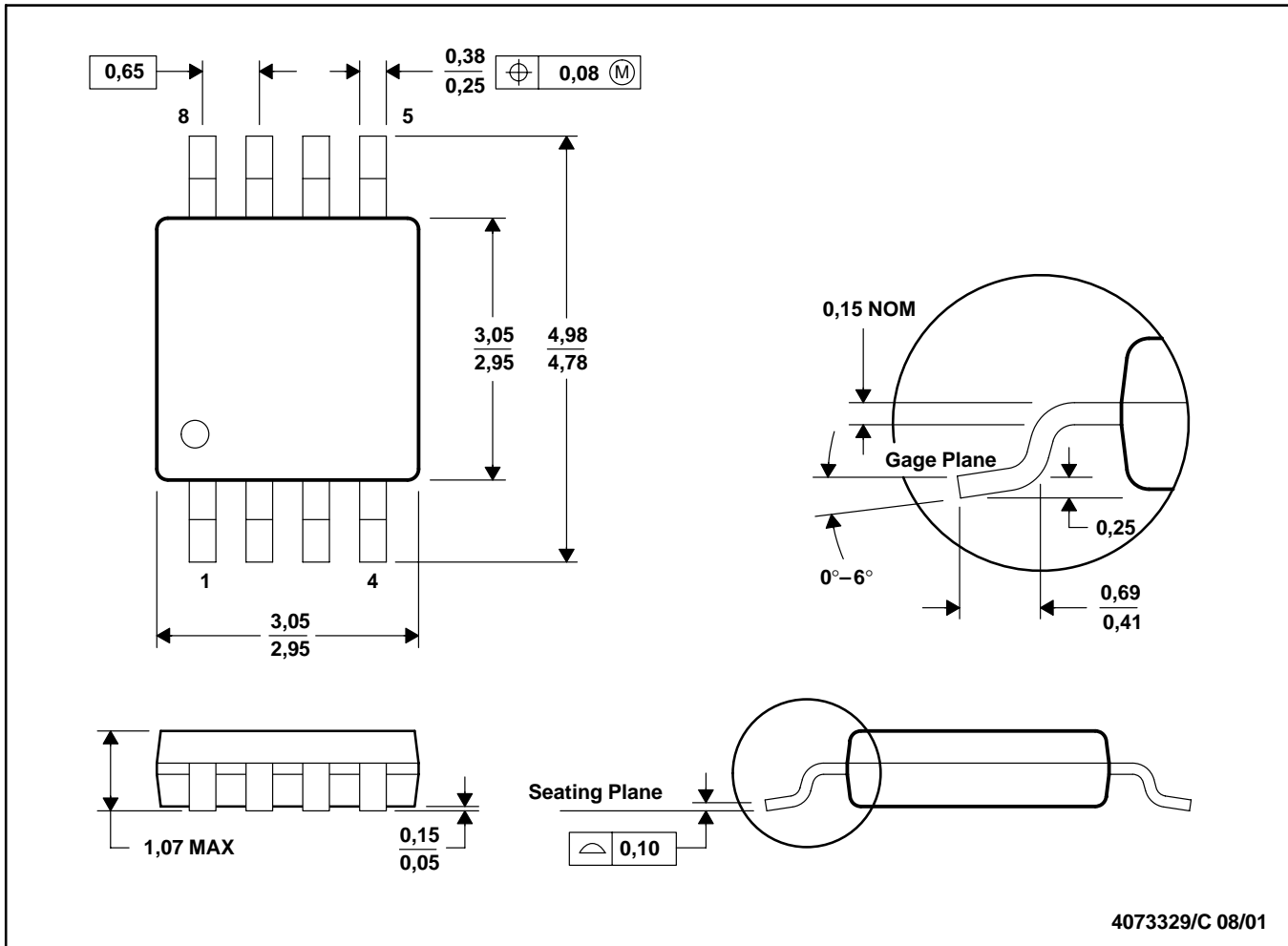

- NOTES:
- A. All linear dimensions are in millimeters.
 - B. This drawing is subject to change without notice.
 - C. Body dimensions do not include mold flash or protrusion.
 - D. Falls within JEDEC MO-187

D (R-PDSO-G**)

PLASTIC SMALL-OUTLINE PACKAGE

8 PINS SHOWN

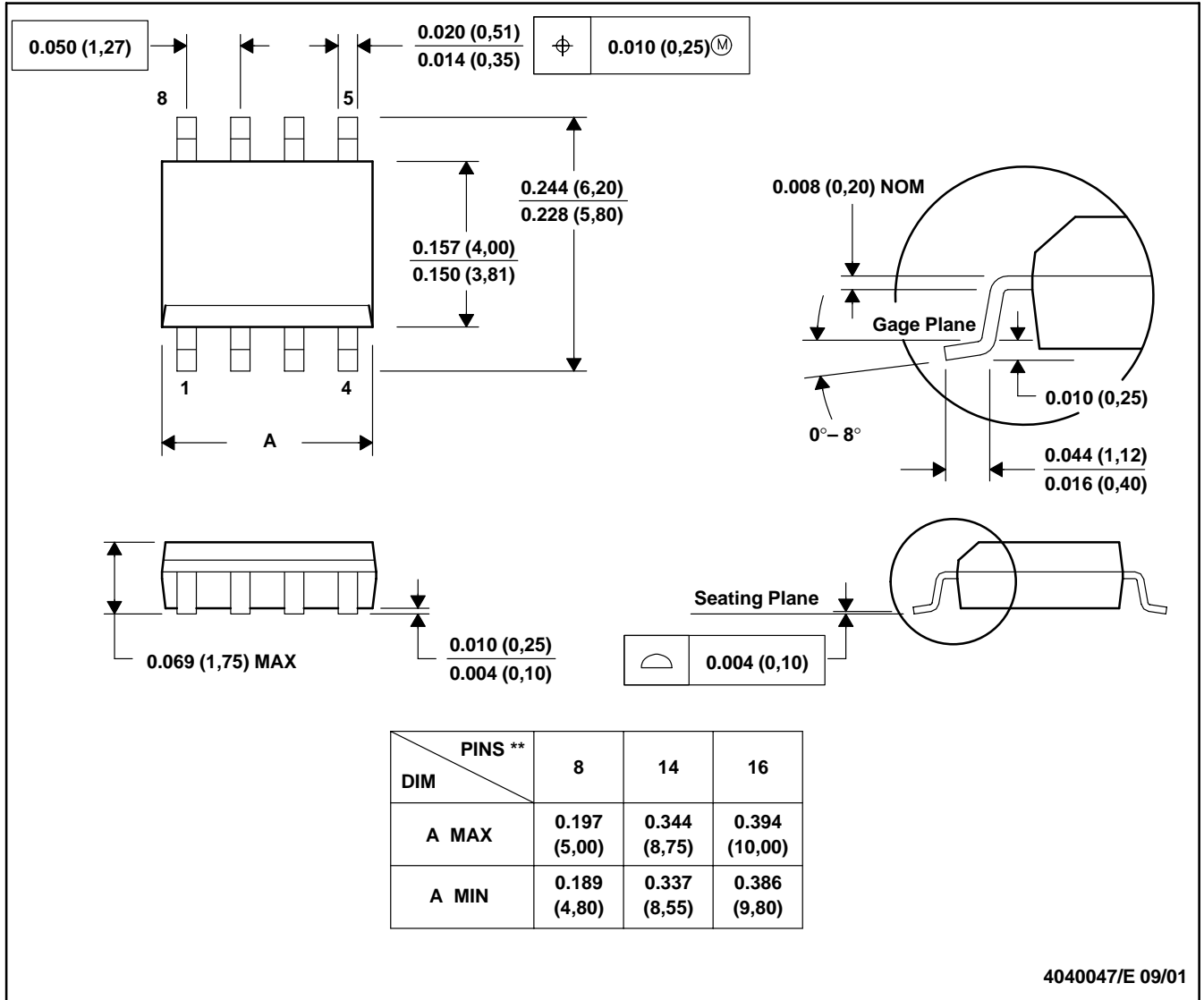

- NOTES: A. All linear dimensions are in inches (millimeters).
 B. This drawing is subject to change without notice.
 C. Body dimensions do not include mold flash or protrusion, not to exceed 0.006 (0,15).
 D. Falls within JEDEC MS-012

PACKAGING INFORMATION

Orderable Device	Status ⁽¹⁾	Package Type	Package Drawing	Pins	Package Qty	Eco Plan ⁽²⁾	Lead/Ball Finish	MSL Peak Temp ⁽³⁾
OPA2356AID	ACTIVE	SOIC	D	8	100	Green (RoHS & no Sb/Br)	CU NIPDAU	Level-2-260C-1 YEAR
OPA2356AIDG4	ACTIVE	SOIC	D	8	100	Green (RoHS & no Sb/Br)	CU NIPDAU	Level-2-260C-1 YEAR
OPA2356AIDGKR	ACTIVE	MSOP	DGK	8	2500	Green (RoHS & no Sb/Br)	CU NIPDAU	Level-2-260C-1 YEAR
OPA2356AIDGKRG4	ACTIVE	MSOP	DGK	8	2500	Green (RoHS & no Sb/Br)	CU NIPDAU	Level-2-260C-1 YEAR
OPA2356AIDGKT	ACTIVE	MSOP	DGK	8	250	Green (RoHS & no Sb/Br)	CU NIPDAU	Level-2-260C-1 YEAR
OPA2356AIDGKTG4	ACTIVE	MSOP	DGK	8	250	Green (RoHS & no Sb/Br)	CU NIPDAU	Level-2-260C-1 YEAR
OPA2356AIDR	ACTIVE	SOIC	D	8	2500	Green (RoHS & no Sb/Br)	CU NIPDAU	Level-2-260C-1 YEAR
OPA2356AIDRG4	ACTIVE	SOIC	D	8	2500	Green (RoHS & no Sb/Br)	CU NIPDAU	Level-2-260C-1 YEAR
OPA356AID	ACTIVE	SOIC	D	8	100	Green (RoHS & no Sb/Br)	CU NIPDAU	Level-2-260C-1 YEAR
OPA356AIDBVR	ACTIVE	SOT-23	DBV	5	3000	Green (RoHS & no Sb/Br)	CU NIPDAU	Level-2-260C-1 YEAR
OPA356AIDBVRG4	ACTIVE	SOT-23	DBV	5	3000	Green (RoHS & no Sb/Br)	CU NIPDAU	Level-2-260C-1 YEAR
OPA356AIDBVT	ACTIVE	SOT-23	DBV	5	250	Green (RoHS & no Sb/Br)	CU NIPDAU	Level-2-260C-1 YEAR
OPA356AIDBVTG4	ACTIVE	SOT-23	DBV	5	250	Green (RoHS & no Sb/Br)	CU NIPDAU	Level-2-260C-1 YEAR
OPA356AIDG4	ACTIVE	SOIC	D	8	100	Green (RoHS & no Sb/Br)	CU NIPDAU	Level-2-260C-1 YEAR
OPA356AIDR	ACTIVE	SOIC	D	8	2500	Green (RoHS & no Sb/Br)	CU NIPDAU	Level-2-260C-1 YEAR
OPA356AIDRG4	ACTIVE	SOIC	D	8	2500	Green (RoHS & no Sb/Br)	CU NIPDAU	Level-2-260C-1 YEAR

⁽¹⁾ The marketing status values are defined as follows:

ACTIVE: Product device recommended for new designs.

LIFEBUY: TI has announced that the device will be discontinued, and a lifetime-buy period is in effect.

NRND: Not recommended for new designs. Device is in production to support existing customers, but TI does not recommend using this part in a new design.

PREVIEW: Device has been announced but is not in production. Samples may or may not be available.

OBSOLETE: TI has discontinued the production of the device.

⁽²⁾ Eco Plan - The planned eco-friendly classification: Pb-Free (RoHS), Pb-Free (RoHS Exempt), or Green (RoHS & no Sb/Br) - please check <http://www.ti.com/productcontent> for the latest availability information and additional product content details.

TBD: The Pb-Free/Green conversion plan has not been defined.

Pb-Free (RoHS): TI's terms "Lead-Free" or "Pb-Free" mean semiconductor products that are compatible with the current RoHS requirements for all 6 substances, including the requirement that lead not exceed 0.1% by weight in homogeneous materials. Where designed to be soldered at high temperatures, TI Pb-Free products are suitable for use in specified lead-free processes.

Pb-Free (RoHS Exempt): This component has a RoHS exemption for either 1) lead-based flip-chip solder bumps used between the die and package, or 2) lead-based die adhesive used between the die and leadframe. The component is otherwise considered Pb-Free (RoHS compatible) as defined above.

Green (RoHS & no Sb/Br): TI defines "Green" to mean Pb-Free (RoHS compatible), and free of Bromine (Br) and Antimony (Sb) based flame retardants (Br or Sb do not exceed 0.1% by weight in homogeneous material)

⁽³⁾ MSL, Peak Temp. -- The Moisture Sensitivity Level rating according to the JEDEC industry standard classifications, and peak solder temperature.

Important Information and Disclaimer:The information provided on this page represents TI's knowledge and belief as of the date that it is provided. TI bases its knowledge and belief on information provided by third parties, and makes no representation or warranty as to the accuracy of such information. Efforts are underway to better integrate information from third parties. TI has taken and continues to take reasonable steps to provide representative and accurate information but may not have conducted destructive testing or chemical analysis on incoming materials and chemicals. TI and TI suppliers consider certain information to be proprietary, and thus CAS numbers and other limited information may not be available for release.

In no event shall TI's liability arising out of such information exceed the total purchase price of the TI part(s) at issue in this document sold by TI to Customer on an annual basis.

TAPE AND REEL INFORMATION



QUADRANT ASSIGNMENTS FOR PIN 1 ORIENTATION IN TAPE



*All dimensions are nominal

Device	Package Type	Package Drawing	Pins	SPQ	Reel Diameter (mm)	Reel Width W1 (mm)	A0 (mm)	B0 (mm)	K0 (mm)	P1 (mm)	W (mm)	Pin1 Quadrant
OPA2356AIDGKR	MSOP	DGK	8	2500	330.0	12.4	5.3	3.4	1.4	8.0	12.0	Q1
OPA2356AIDGKT	MSOP	DGK	8	250	180.0	12.4	5.3	3.4	1.4	8.0	12.0	Q1
OPA2356AIDR	SOIC	D	8	2500	330.0	12.4	6.4	5.2	2.1	8.0	12.0	Q1
OPA356AIDBVR	SOT-23	DBV	5	3000	180.0	8.4	3.2	3.1	1.39	4.0	8.0	Q3
OPA356AIDBVT	SOT-23	DBV	5	250	180.0	8.4	3.2	3.1	1.39	4.0	8.0	Q3
OPA356AIDR	SOIC	D	8	2500	330.0	12.4	6.4	5.2	2.1	8.0	12.0	Q1

TAPE AND REEL BOX DIMENSIONS



*All dimensions are nominal

Device	Package Type	Package Drawing	Pins	SPQ	Length (mm)	Width (mm)	Height (mm)
OPA2356AIDGKR	MSOP	DGK	8	2500	346.0	346.0	29.0
OPA2356AIDGKT	MSOP	DGK	8	250	184.0	184.0	50.0
OPA2356AIDR	SOIC	D	8	2500	346.0	346.0	29.0
OPA356AIDBVR	SOT-23	DBV	5	3000	190.5	212.7	31.8
OPA356AIDBVT	SOT-23	DBV	5	250	190.5	212.7	31.8
OPA356AIDR	SOIC	D	8	2500	346.0	346.0	29.0

IMPORTANT NOTICE

Texas Instruments Incorporated and its subsidiaries (TI) reserve the right to make corrections, modifications, enhancements, improvements, and other changes to its products and services at any time and to discontinue any product or service without notice. Customers should obtain the latest relevant information before placing orders and should verify that such information is current and complete. All products are sold subject to TI's terms and conditions of sale supplied at the time of order acknowledgment.

TI warrants performance of its hardware products to the specifications applicable at the time of sale in accordance with TI's standard warranty. Testing and other quality control techniques are used to the extent TI deems necessary to support this warranty. Except where mandated by government requirements, testing of all parameters of each product is not necessarily performed.

TI assumes no liability for applications assistance or customer product design. Customers are responsible for their products and applications using TI components. To minimize the risks associated with customer products and applications, customers should provide adequate design and operating safeguards.

TI does not warrant or represent that any license, either express or implied, is granted under any TI patent right, copyright, mask work right, or other TI intellectual property right relating to any combination, machine, or process in which TI products or services are used. Information published by TI regarding third-party products or services does not constitute a license from TI to use such products or services or a warranty or endorsement thereof. Use of such information may require a license from a third party under the patents or other intellectual property of the third party, or a license from TI under the patents or other intellectual property of TI.

Reproduction of TI information in TI data books or data sheets is permissible only if reproduction is without alteration and is accompanied by all associated warranties, conditions, limitations, and notices. Reproduction of this information with alteration is an unfair and deceptive business practice. TI is not responsible or liable for such altered documentation. Information of third parties may be subject to additional restrictions.

Resale of TI products or services with statements different from or beyond the parameters stated by TI for that product or service voids all express and any implied warranties for the associated TI product or service and is an unfair and deceptive business practice. TI is not responsible or liable for any such statements.

TI products are not authorized for use in safety-critical applications (such as life support) where a failure of the TI product would reasonably be expected to cause severe personal injury or death, unless officers of the parties have executed an agreement specifically governing such use. Buyers represent that they have all necessary expertise in the safety and regulatory ramifications of their applications, and acknowledge and agree that they are solely responsible for all legal, regulatory and safety-related requirements concerning their products and any use of TI products in such safety-critical applications, notwithstanding any applications-related information or support that may be provided by TI. Further, Buyers must fully indemnify TI and its representatives against any damages arising out of the use of TI products in such safety-critical applications.

TI products are neither designed nor intended for use in military/aerospace applications or environments unless the TI products are specifically designated by TI as military-grade or "enhanced plastic." Only products designated by TI as military-grade meet military specifications. Buyers acknowledge and agree that any such use of TI products which TI has not designated as military-grade is solely at the Buyer's risk, and that they are solely responsible for compliance with all legal and regulatory requirements in connection with such use.

TI products are neither designed nor intended for use in automotive applications or environments unless the specific TI products are designated by TI as compliant with ISO/TS 16949 requirements. Buyers acknowledge and agree that, if they use any non-designated products in automotive applications, TI will not be responsible for any failure to meet such requirements.

Following are URLs where you can obtain information on other Texas Instruments products and application solutions:

Products

Amplifiers	amplifier.ti.com
Data Converters	dataconverter.ti.com
DSP	dsp.ti.com
Clocks and Timers	www.ti.com/clocks
Interface	interface.ti.com
Logic	logic.ti.com
Power Mgmt	power.ti.com
Microcontrollers	microcontroller.ti.com
RFID	www.ti-rfid.com
RF/IF and ZigBee® Solutions	www.ti.com/lprf

Applications

Audio	www.ti.com/audio
Automotive	www.ti.com/automotive
Broadband	www.ti.com/broadband
Digital Control	www.ti.com/digitalcontrol
Medical	www.ti.com/medical
Military	www.ti.com/military
Optical Networking	www.ti.com/opticalnetwork
Security	www.ti.com/security
Telephony	www.ti.com/telephony
Video & Imaging	www.ti.com/video
Wireless	www.ti.com/wireless

Mailing Address: Texas Instruments, Post Office Box 655303, Dallas, Texas 75265
Copyright © 2008, Texas Instruments Incorporated